

Name : \_\_\_\_\_

Score : \_\_\_\_\_ Date : \_\_\_\_\_

**Area of Triangles and Parallelograms Worksheet**

Find the area of the following triangles

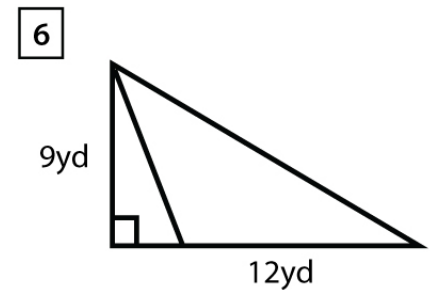
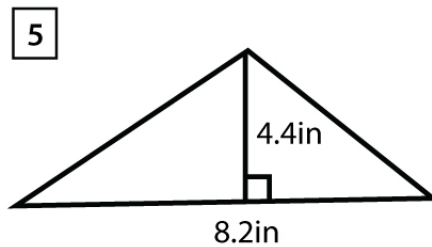
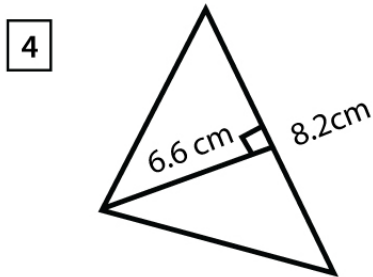
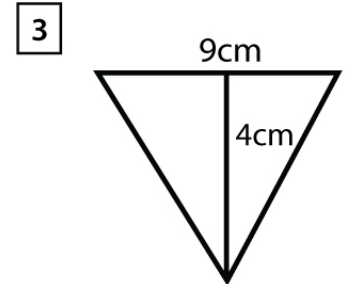
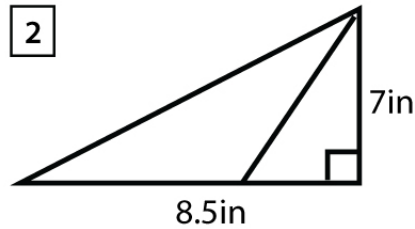
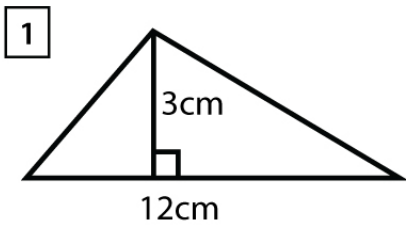

Find the area of the following parallelograms.

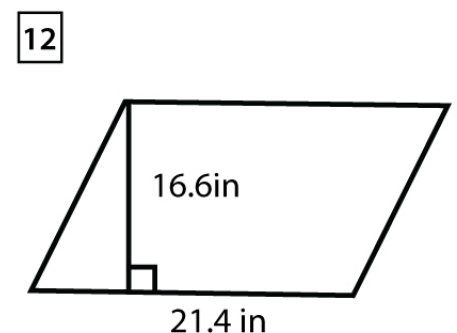
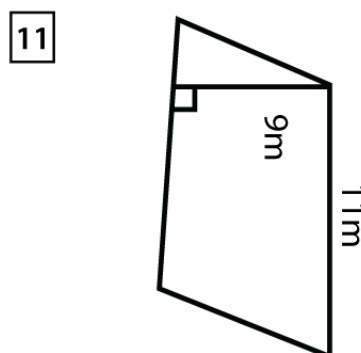
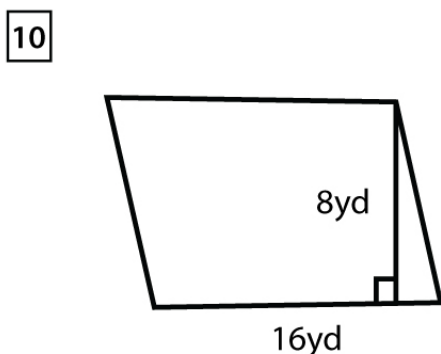
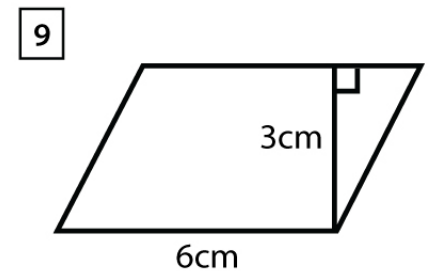
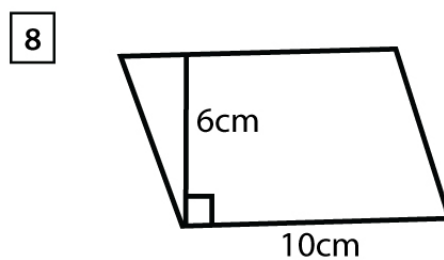
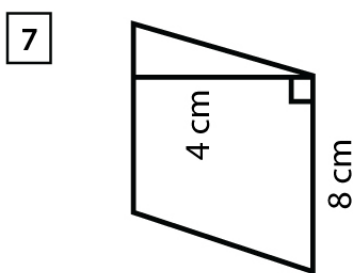

Name : \_\_\_\_\_

Score : \_\_\_\_\_ Date : \_\_\_\_\_

Area of Triangles and Parallelograms Worksheet

Answers

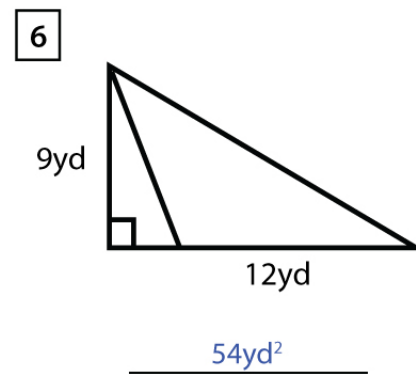
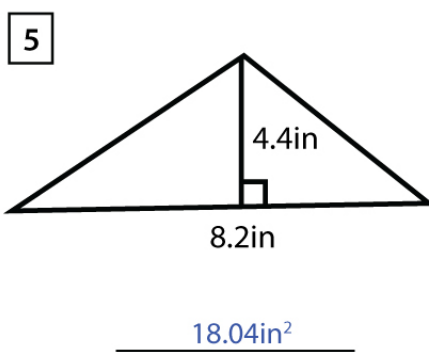
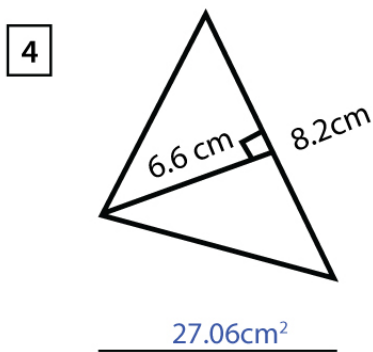
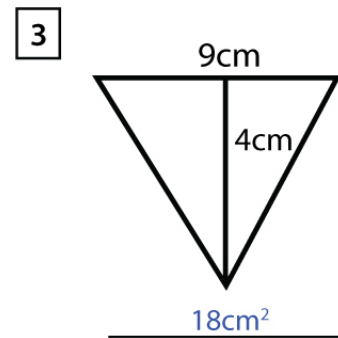
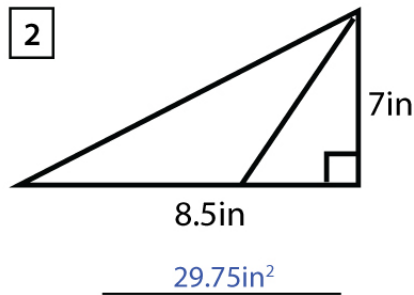
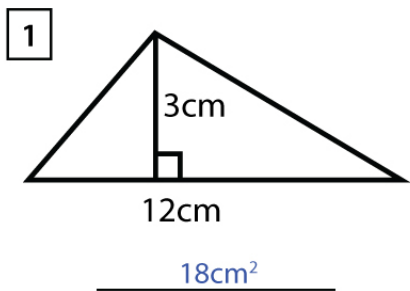

Find the area of the following parallelograms.

