

Name : _____

Score : _____ Date : _____

Circle - Circumference

Calculate the circumference of each circle from the given radius or diameter.

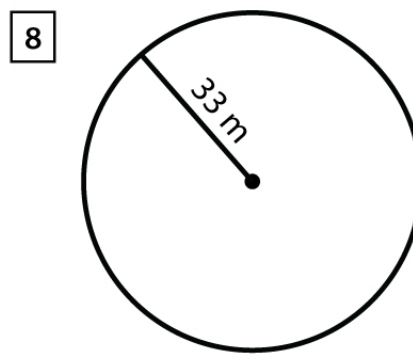
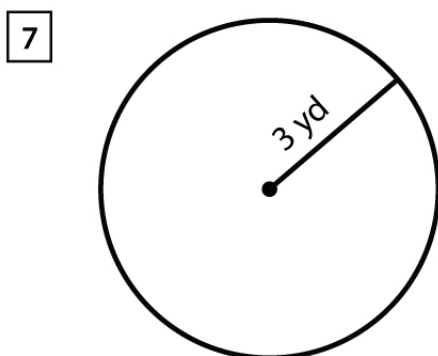
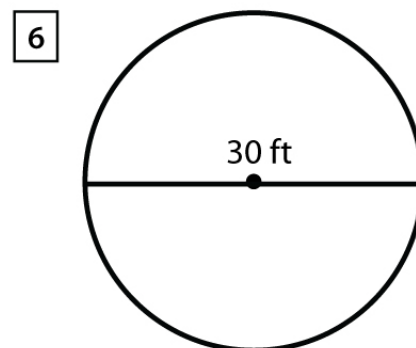
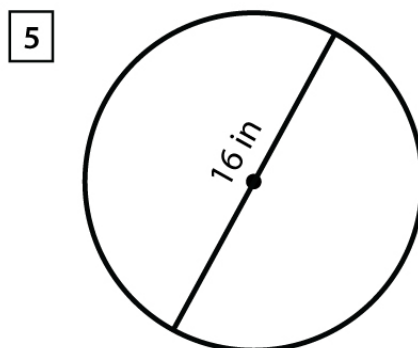
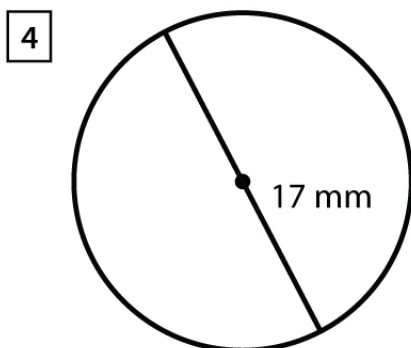
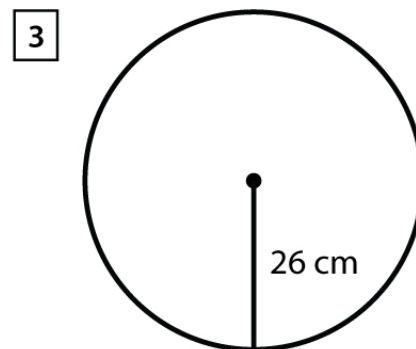
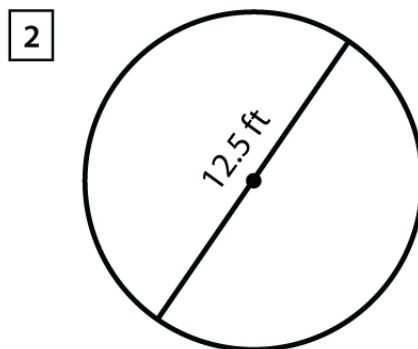
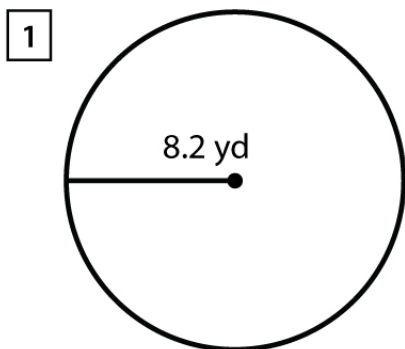

Name : _____

Score : _____ Date : _____

Circle - Circumference

Answers

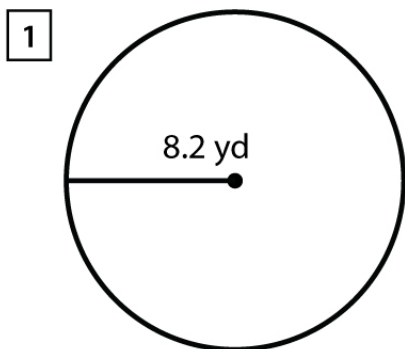

51.52 yd

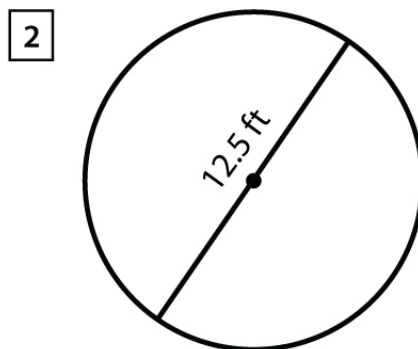

39.26 ft

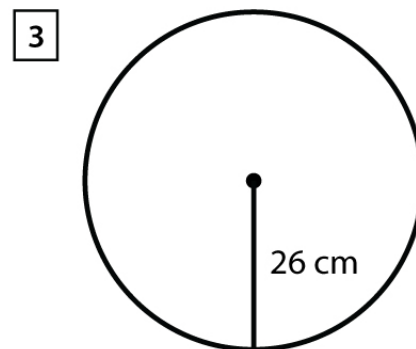

163.36 cm

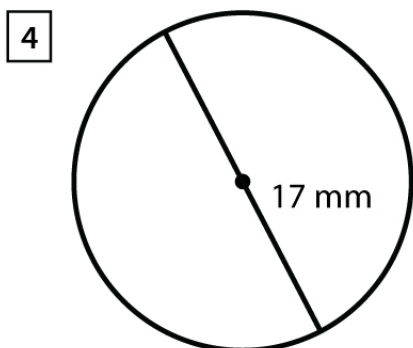

53.40 mm

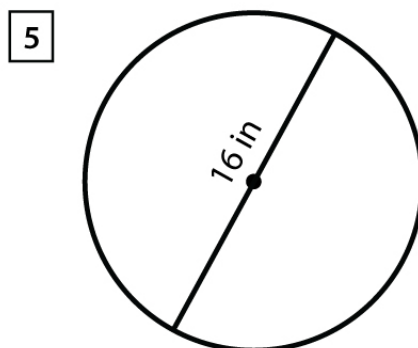

50.26 in

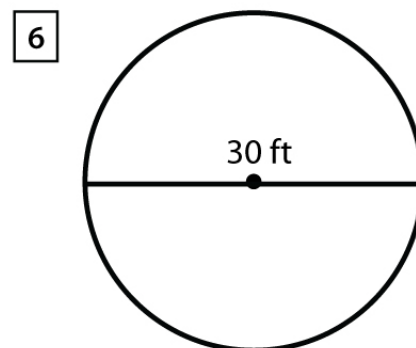

94.24 ft

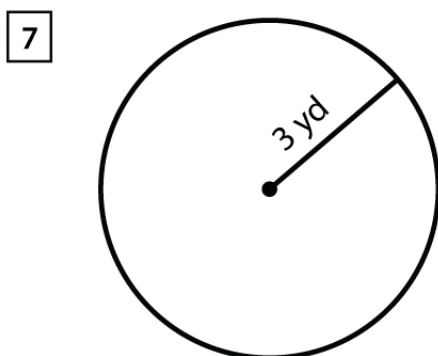

18.84 yd

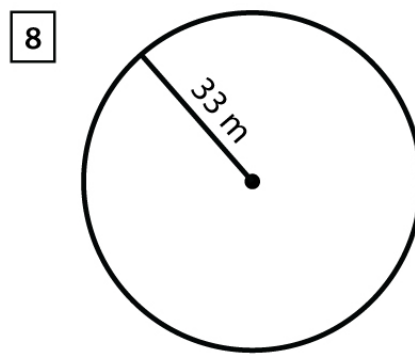

207.34 m