

Similar Triangles with Indirect Measurement Worksheet

Find the unknown variable in the given pair of similar triangles

1

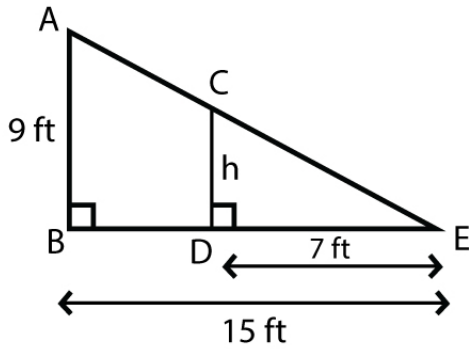

2

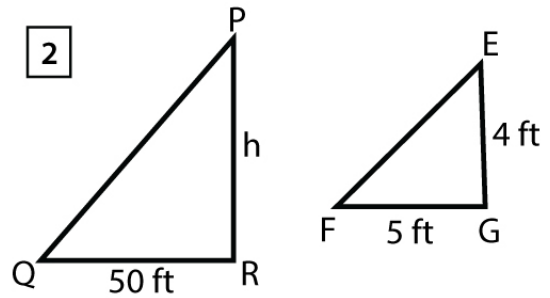

3

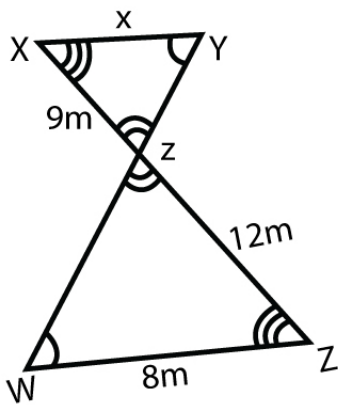

4

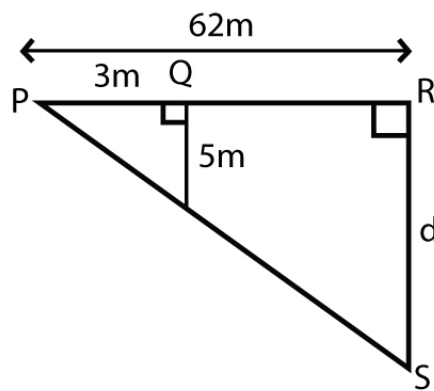

5

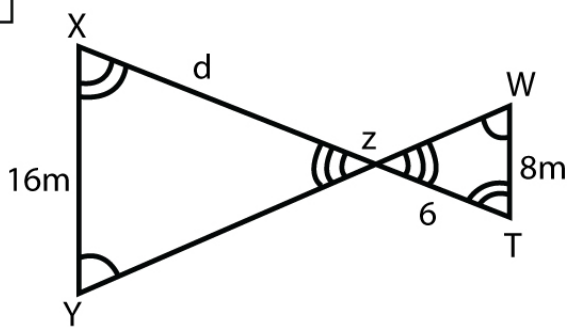

6

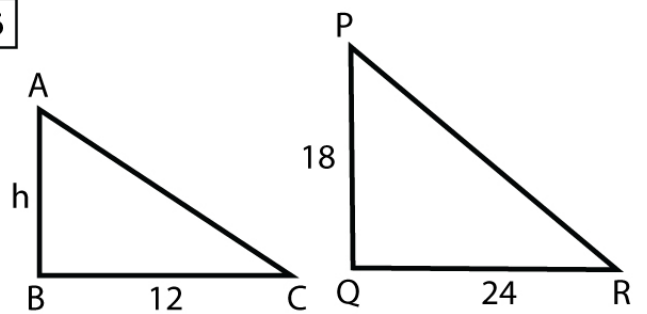

7

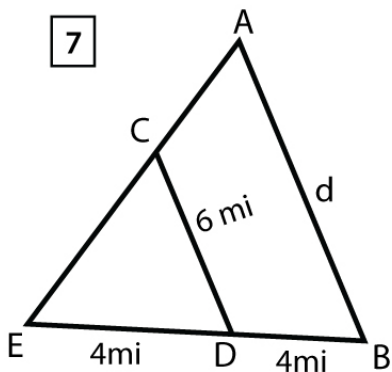

8

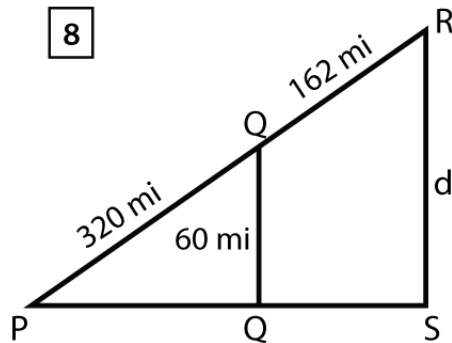

Similar Triangles with Indirect Measurement Worksheet

Answers

1

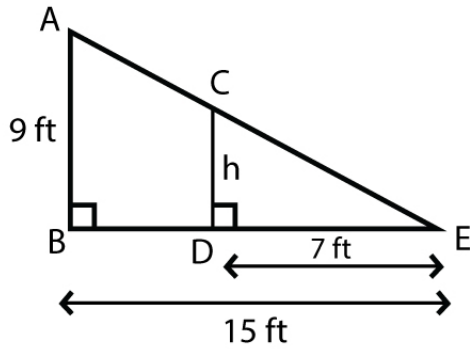

$h = 4.2$

2

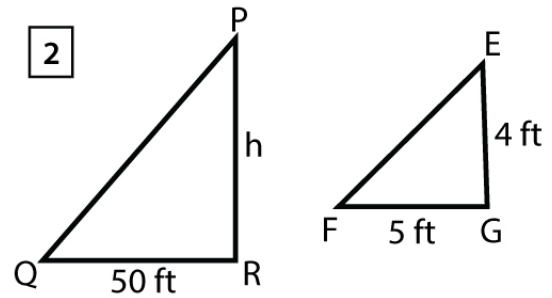

$h = 40 \text{ ft}$

3

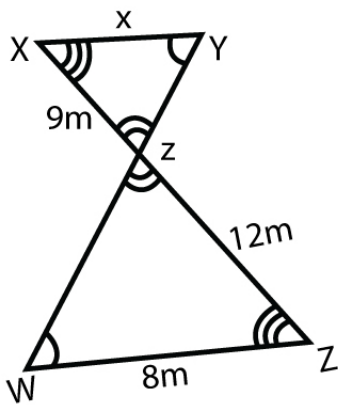

$x = 6$

4

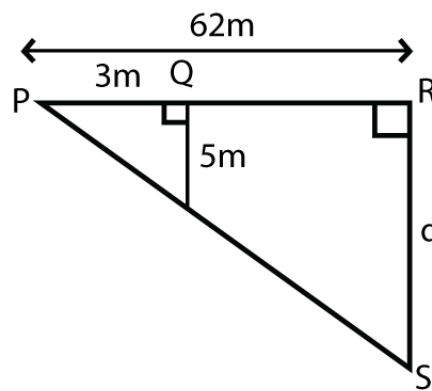

$d = 103.33$

5

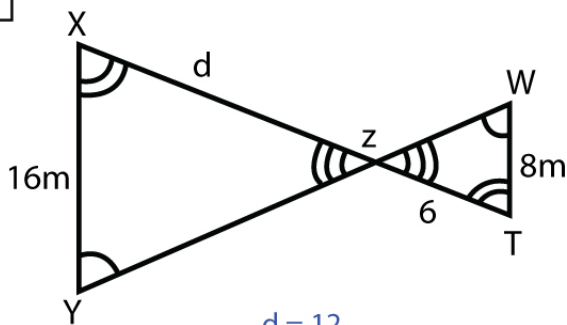

$d = 12$

6

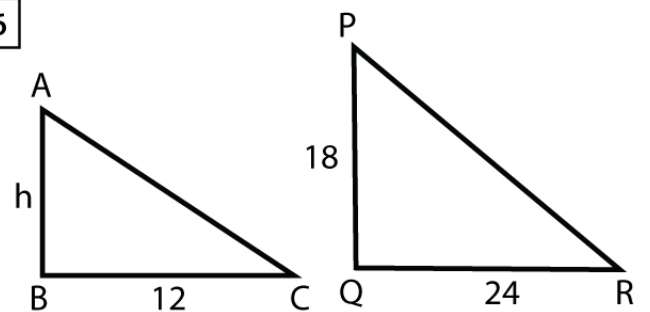

$h = 9$

7

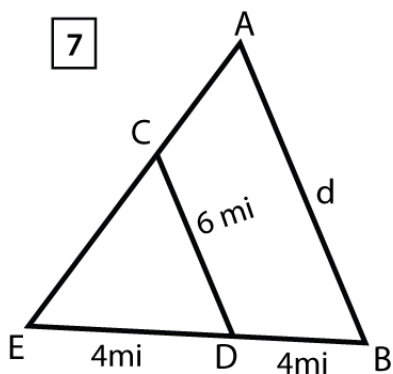

$d = 12$

8

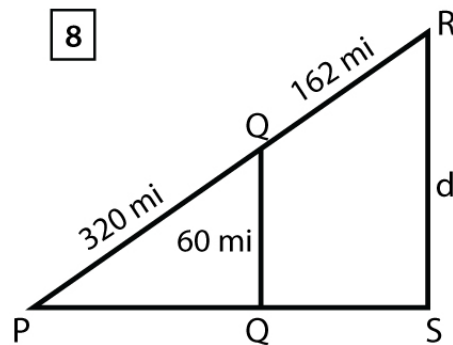

$d = 90.37$