

Name : _____

Score : _____ Date : _____

Identify the Type of Each Triangle

Classify the triangles into acute, obtuse and right with given angles.

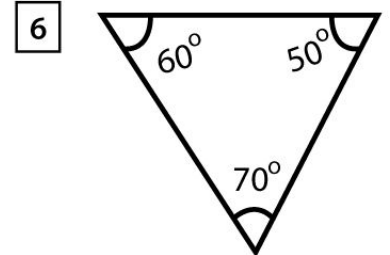
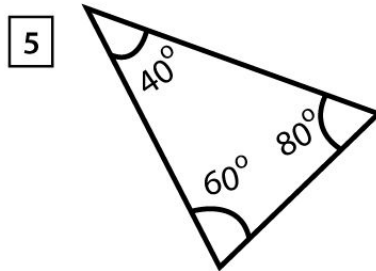
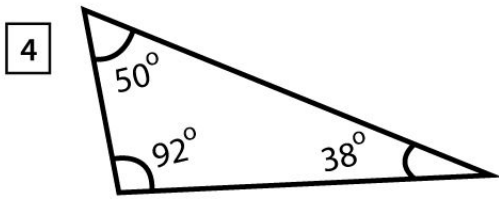
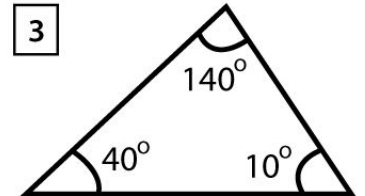
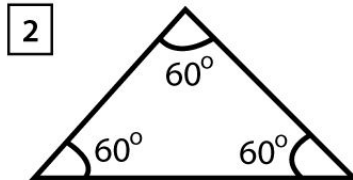
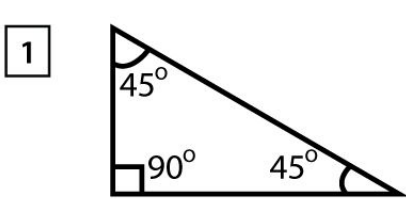

Classify the triangles according to sides as equilateral , isosceles or scalene

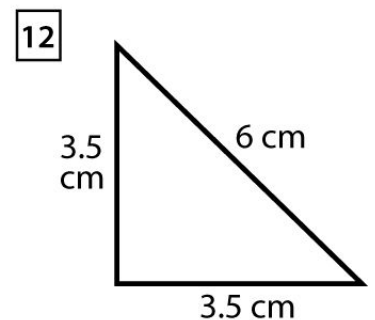
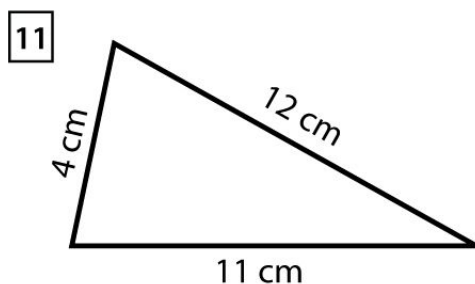
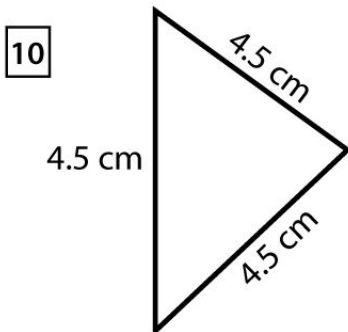
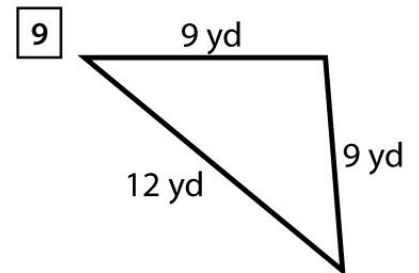
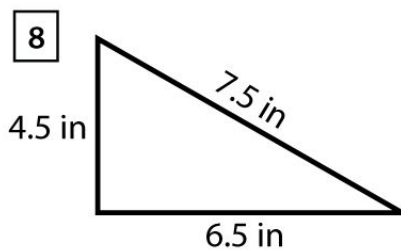
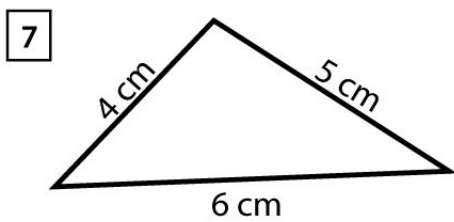

Name : _____

Score : _____ Date : _____

Identify the Type of Each Triangle

Answers

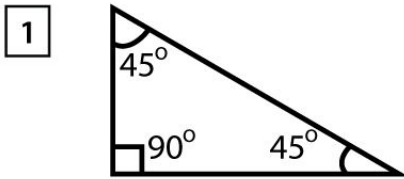

Right

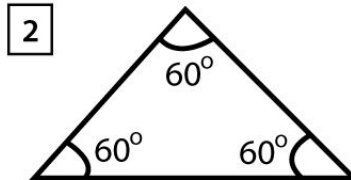

Acute

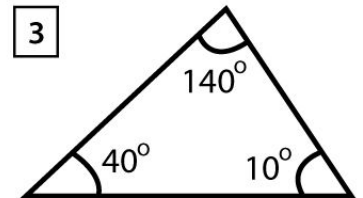

Obtuse

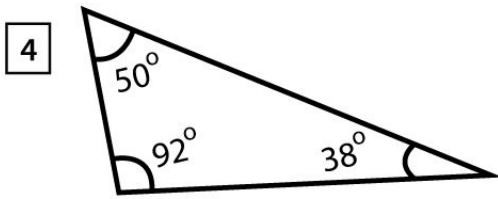

Obtuse

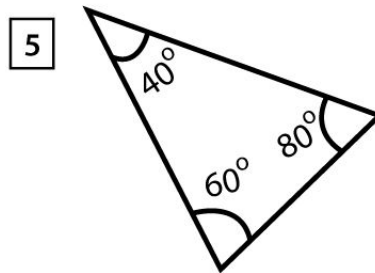

Acute

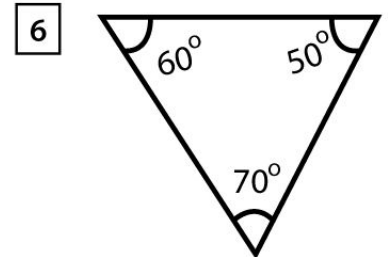

Acute

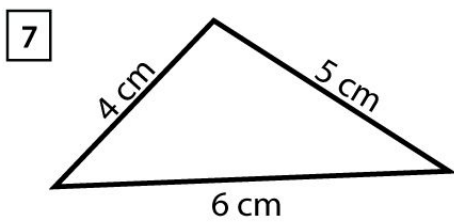

Scalene

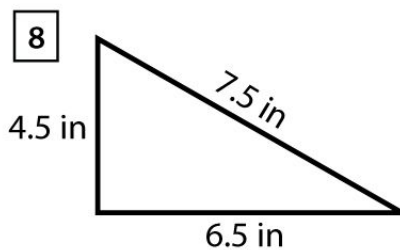

Scalene

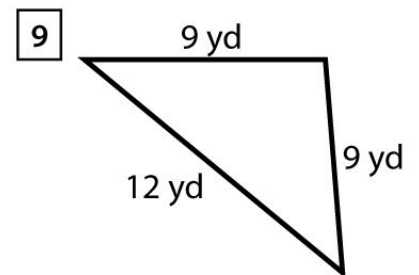

Isosceles

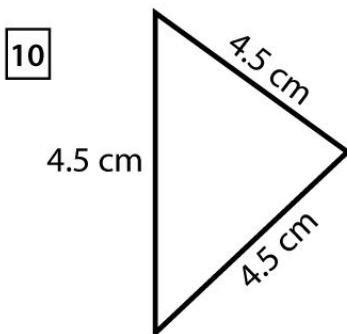

Equilateral

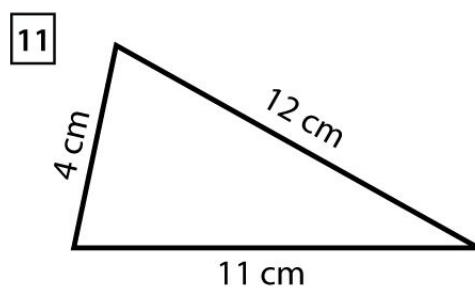

Scalene

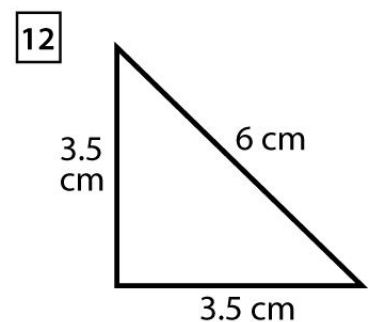

Isosceles