

Name : _____

Score : _____ Date : _____

Finding Interior and Exterior Angles of Polygon Worksheet

Find the value of the unknown angle(s) in each given polygons.

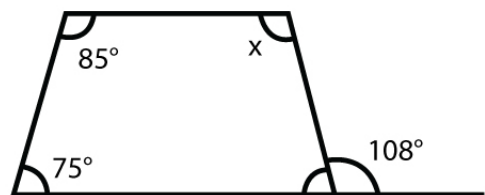
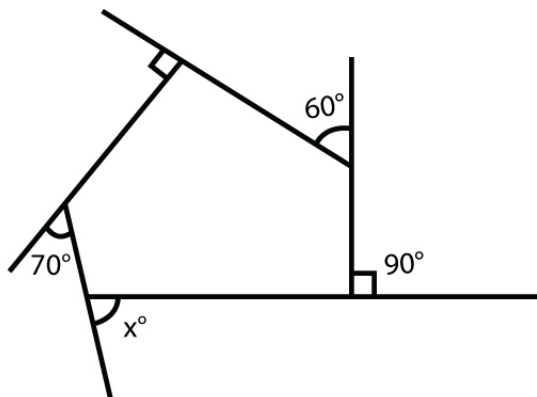
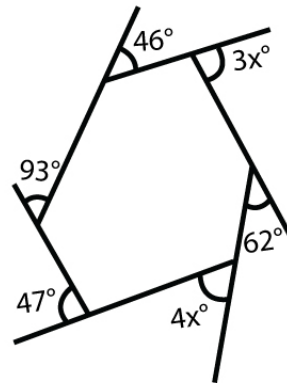
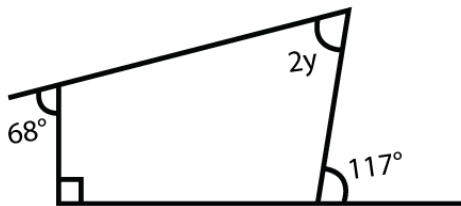
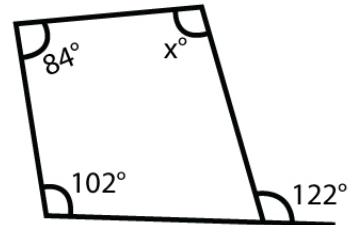
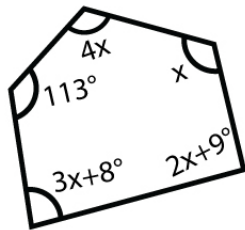
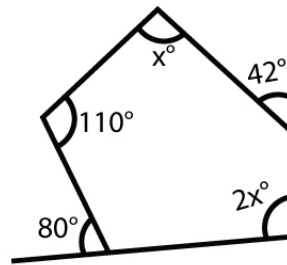
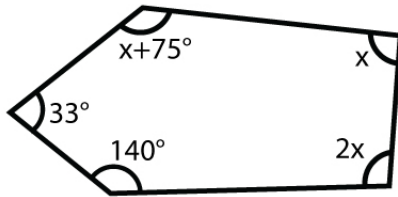

Name : _____

Score : _____ Date : _____

Finding Interior and Exterior Angles of Polygon Worksheet

Answers

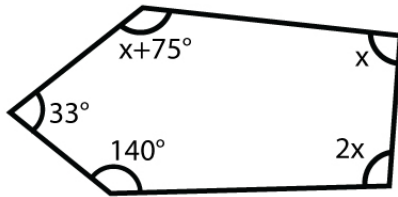

73°, 146°, 148°

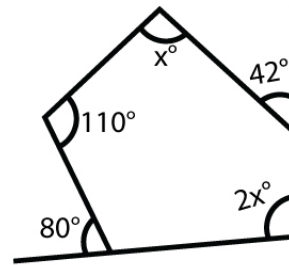

64°, 128°

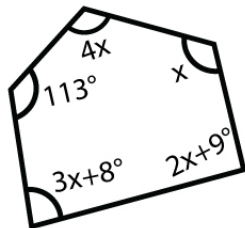

41°, 164°, 131°, 91°

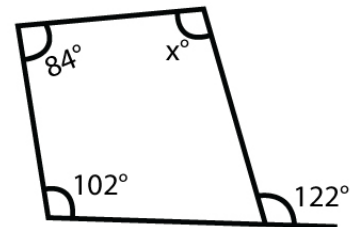

116°

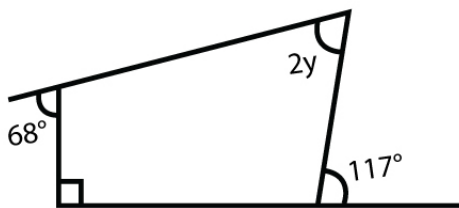

95°

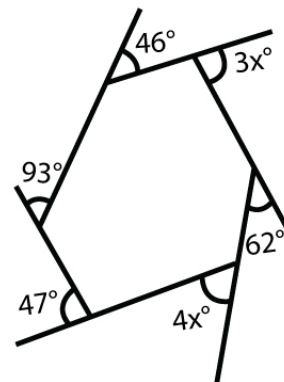

64°, 48°

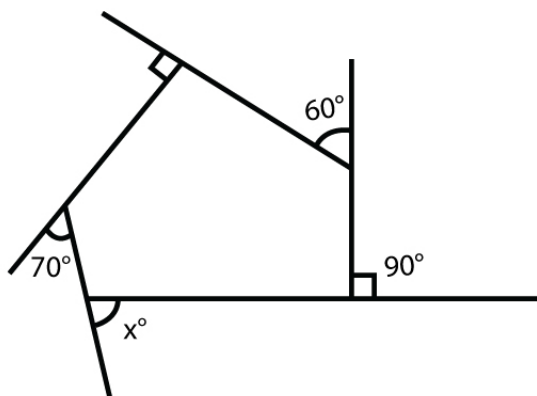

50°

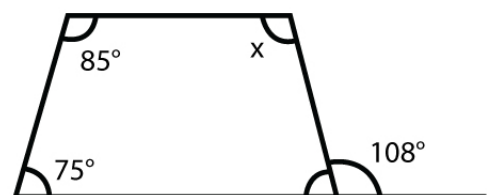

128°