

Name : _____

Score : _____ Date : _____

Similar Polygons Worksheet

State if the polygons are similar

1

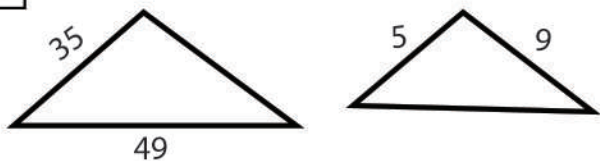

2

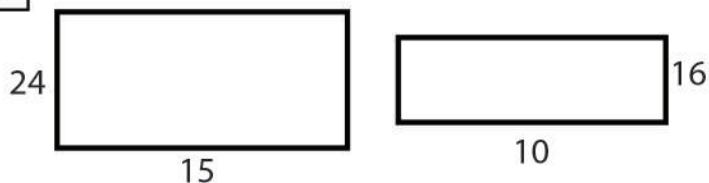

3

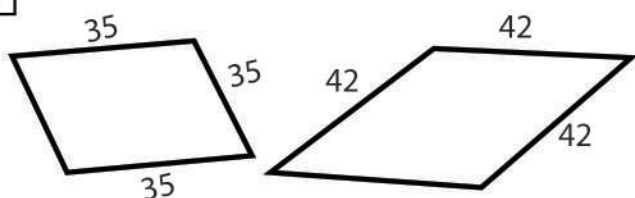

4

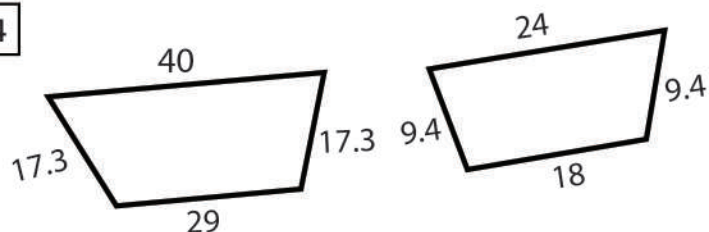

5

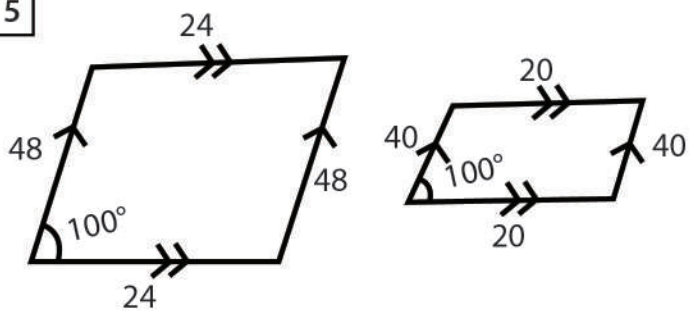

6

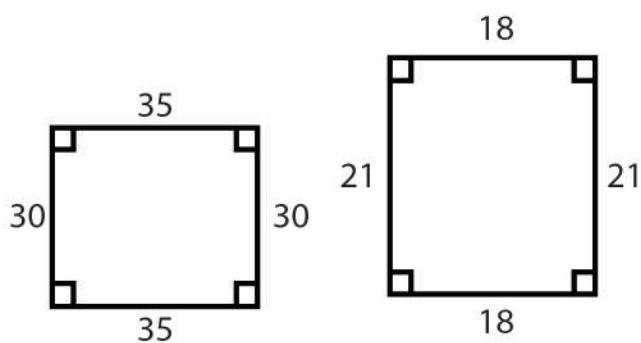

7

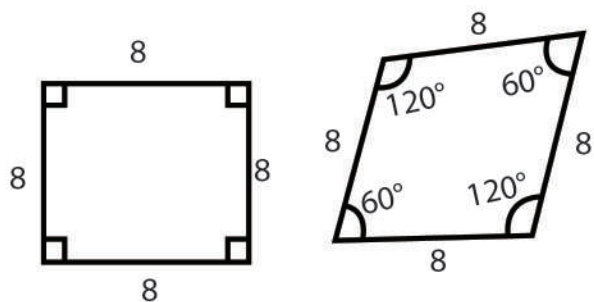

8

