





COLOR BY NUMBER

Color Codes

1 - 5 = 

6 - 10 = 

11 - 15 = 

16 - 20 = 

21 - 25 = 

26 - 30 = 

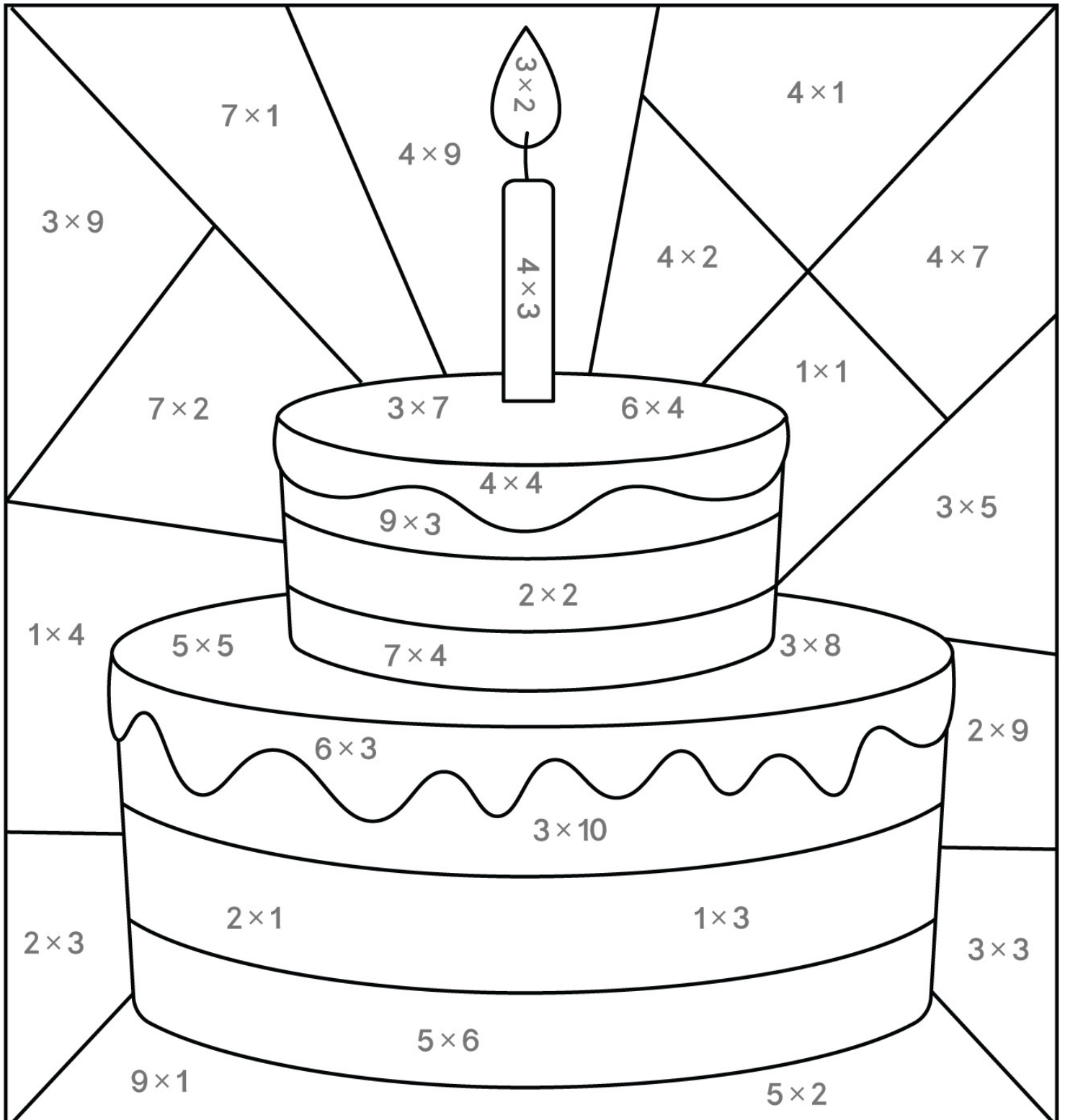



COLOR BY NUMBER

Answers Color Codes

1 - 5 = 

6 - 10 = 

11 - 15 = 

16 - 20 = 

21 - 25 = 

26 - 30 = 