

Pythagoras' Theorem Worksheet

Find the lengths of the unknown sides in the given right triangles.

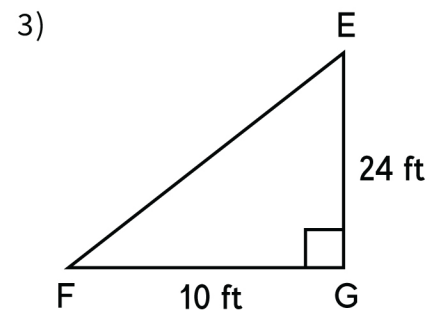
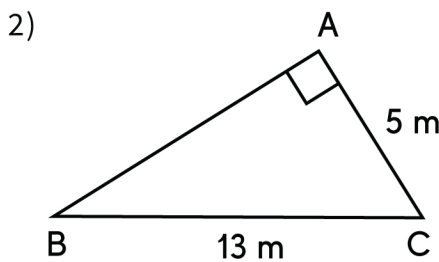
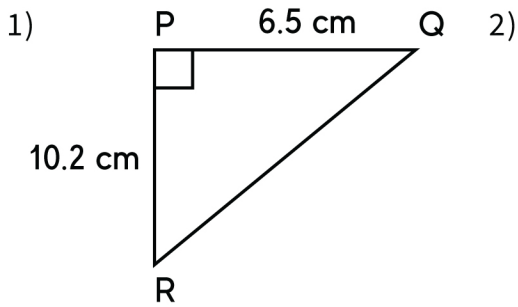

QR = _____

AB = _____

EF = _____

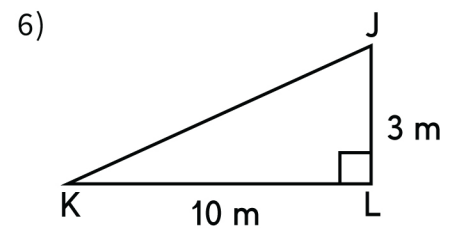
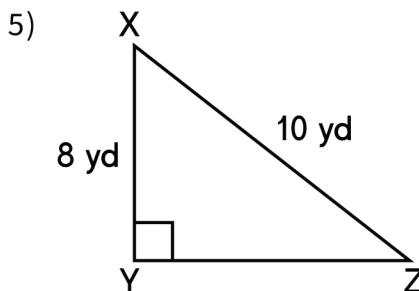
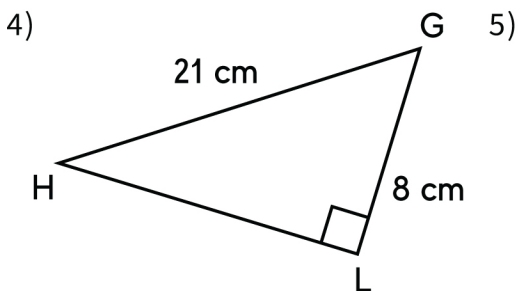

HL = _____

YZ = _____

KJ = _____

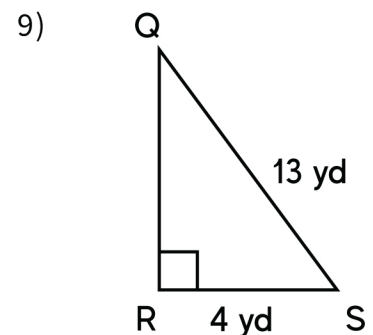
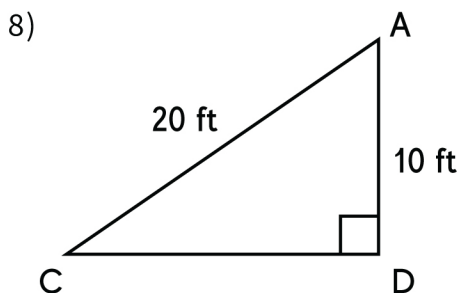
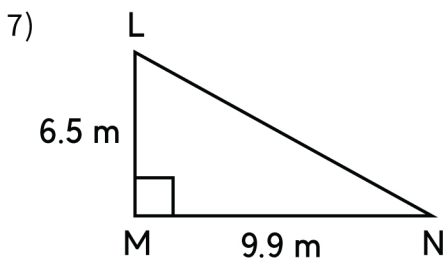

LN = _____

CD = _____

QR = _____

Pythagoras' Theorem Worksheet

Answers

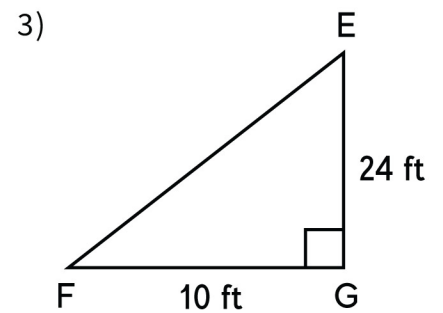
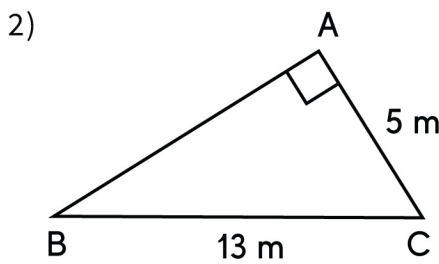
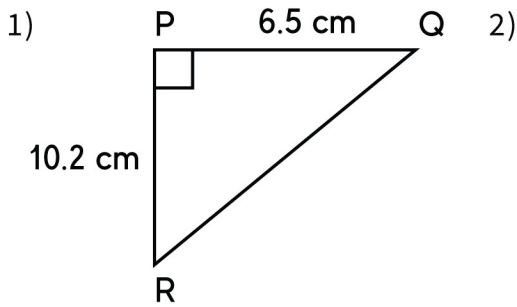

QR = 12.1 cm

AB = 12 m

EF = 26 ft

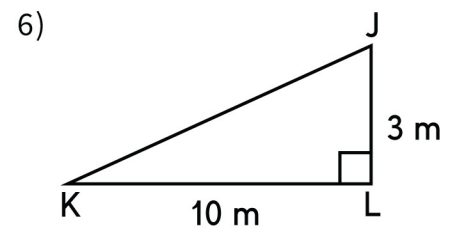
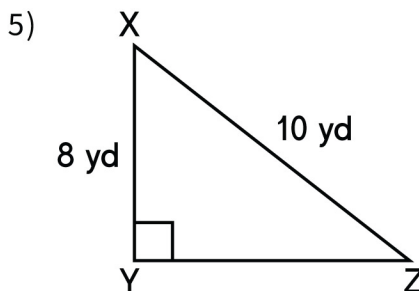
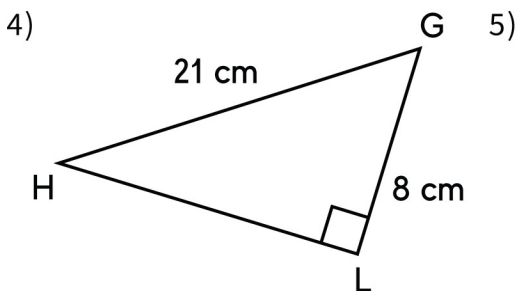

HL = 19.42 cm

YZ = 6 yd

KJ = 10.44 m

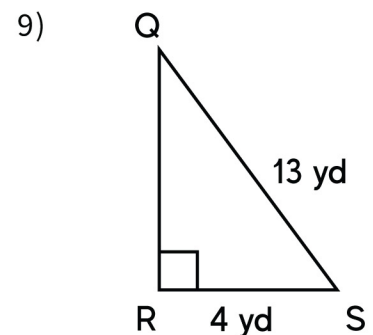
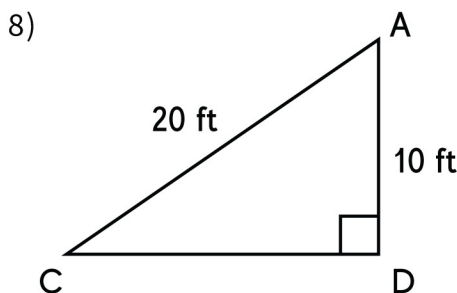
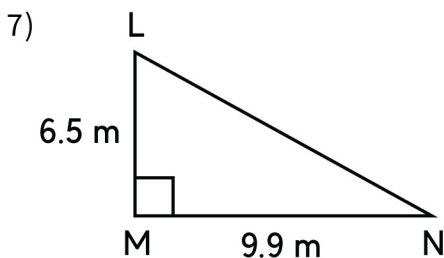

LN = 11.84 m

CD = 17.32 ft

QR = 12.37 yd