

The Pythagorean Theorem Worksheet

Find the length of the missing side in the given right triangles.

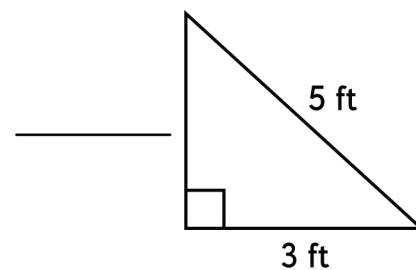
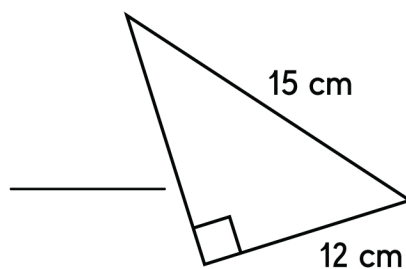
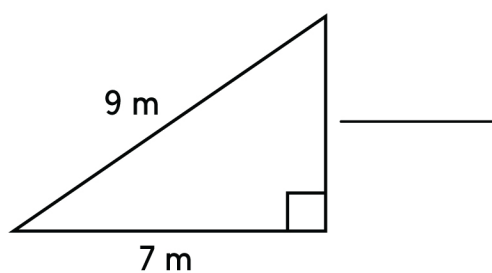
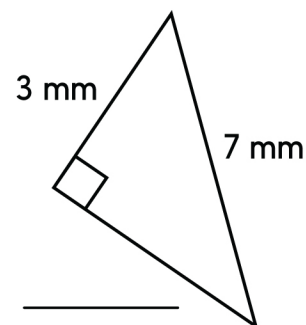
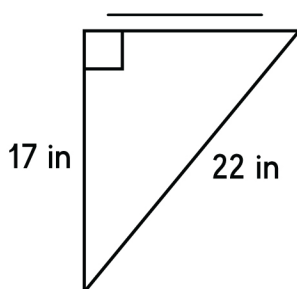
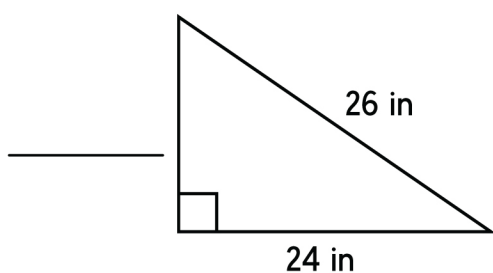
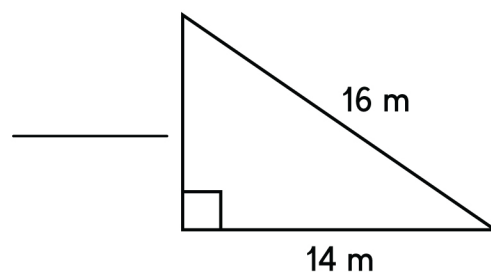
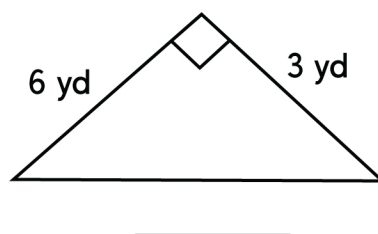
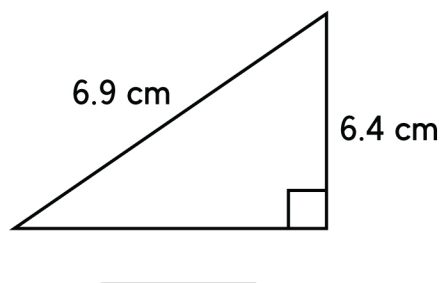
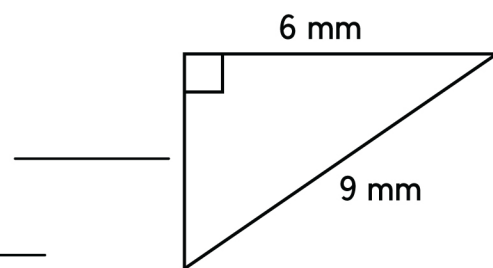
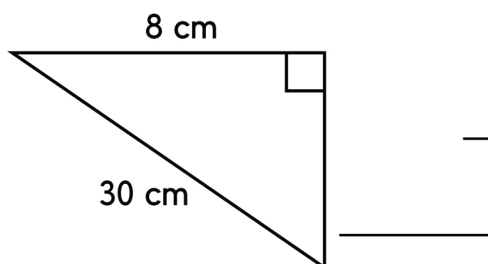
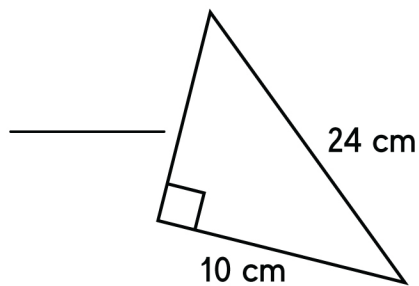

The Pythagorean Theorem Worksheet

Answers

