

Volume *of a* Cube

Find the volume of each cube

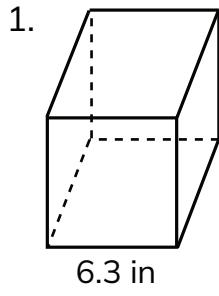

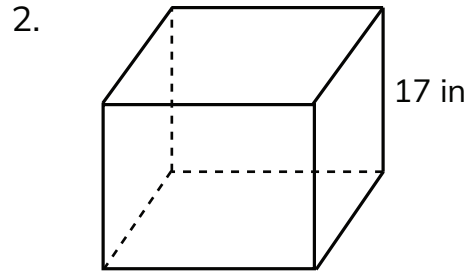

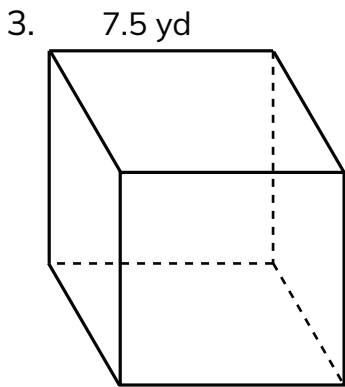

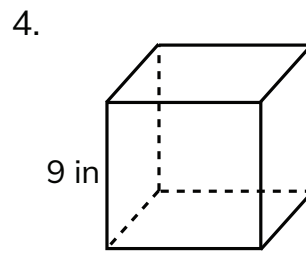

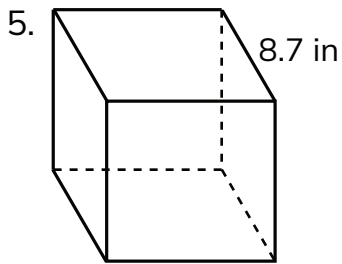

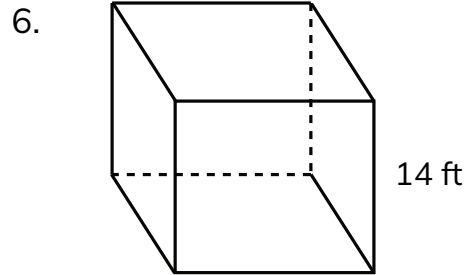

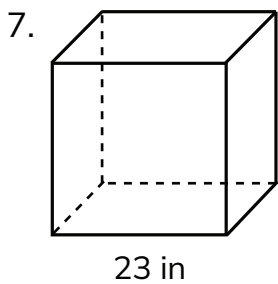

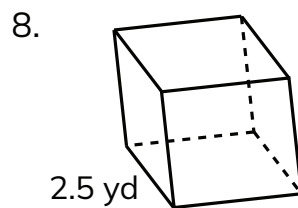

Volume *of a* Cube

Find the volume of each cube
(Answers)

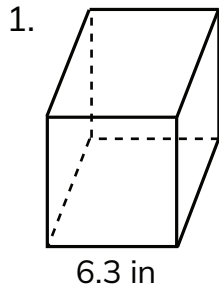

250.047 in³

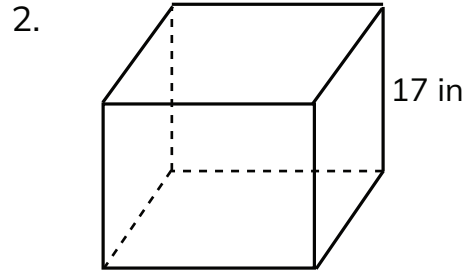

4913 in³

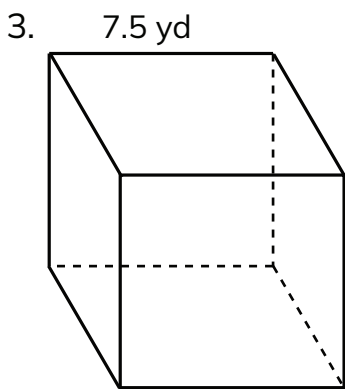

421.875 yd³

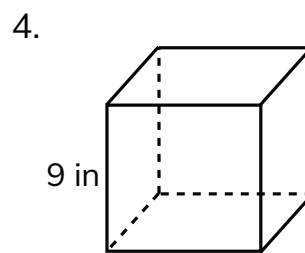

729 in³

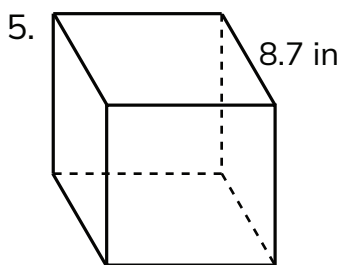

658.503 in³

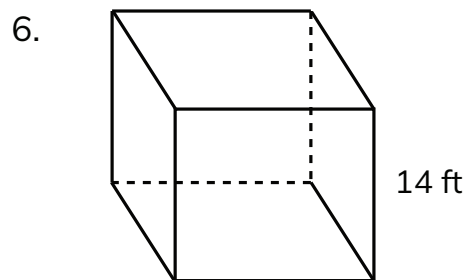

2744 ft³

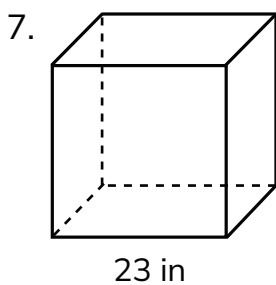

12167 in³

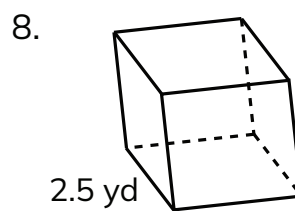

15.625 yd³